



# FA22

Dual 12 inch Coaxial Loudspeaker

*fa*PORTABLE.



## Overview

The FA22 is a portable 3-way coaxial loudspeaker that is well suited for a variety of sound reinforcement applications. Its neodymium coaxial transducer and 90° x 45° horn provide broad coverage that is beneficial in both stage monitor and mains operation, and its dedicated neodymium low frequency transducer provides additional low frequency directivity and mid bass impact. Its multi-faceted, enclosure includes a pole mount socket, 40° and 55° rear angles for stage monitor use, and M10 threaded accessory plates for use with user-supplied suspension hardware. The compact enclosure is vertically-oriented, but if a horizontal orientation is desired, it can be easily obtained by exchanging the pole socket with one of the M10 accessory plates and rotating the coaxial transducer to provide appropriate coverage angles.

Fulcrum Acoustic's **TQ™** processing is an integral part of the FA22 design. Sound, innovative acoustical design combined with state of the art digital processing leads to exceptional clarity and precise transient response, even at very high sound pressure levels. The required digital signal processing can be provided by one of many supported platforms. Free air and stage monitor presets are available for all platforms.

The FA22's unique **TQPassive™** internal crossover is designed to work in conjunction with **TQ™** processing. It provides the high efficiency, excellent damping, and precise directional control normally associated with tri-amplified operation, but it does not require a third amplifier and processor channel. There are no resistive components in the crossover to heat up, so its response remains consistent even at high levels.

The FA22ac's versatility, high performance, and aesthetic appeal make it a compelling choice for A/V rental companies, live performance venues, corporate A/V, nightclub PA, theatrical productions, and more.

## Performance Specifications<sup>1</sup>

### Operating Mode

Bi-amplified w/ DSP

### Operating Range<sup>2</sup>

44 Hz to 20 kHz

### Nominal Beamwidth (rotatable)

90° x 45°

### Transducers

LF: 12.0" neodymium magnet woofer, 3.0" voice coil  
HF/LF: Coaxial 3.0" titanium diaphragm compression driver;  
12.0" woofer, 3.0" voice coil; single neodymium magnet

### Power Handling @ Nominal Impedance<sup>3</sup>

LF: 57 V / 400 W @ 8 Ω  
HF/LF: 57 V / 400 W @ 8 Ω

### Nominal Sensitivity @ Input Voltage<sup>4</sup> (whole space)

LF: 99 dB @ 2.83 V  
HF/LF: 105 dB @ 2.83 V

### Nominal Maximum SPL (peak / continuous)

LF: 131 dB / 125 dB  
HF: 137 dB / 131 dB

### Equalized Sensitivity @ Input Voltage<sup>5</sup>

96 dB @ 2.83 V

### Equalized Maximum SPL<sup>6</sup> (peak / continuous)

130 dB / 124 dB

### Recommended Power Amplifiers

LF: 400 W to 800 W @ 8 Ω  
HF/LF: 400 W to 800 W @ 8 Ω

## Physical Specifications

### Mounting / Suspension Points

(1) 35 mm / 1.38 inch pole socket

(3) M10 nut plates

(2) M10 accessory plates\*

\*M10 thread is sealed. Use bolts with 15-20 mm shank length.

### Dimensions / Weight

See page 5

### Finish

Black painted enclosure w/ matte black grille

## Options

FA22 Padded Bag w/ Logo

SPI Speaker Pole

Mounts to subwoofers with M20-threaded connector plate.

Height-adjustable between 905 mm / 35.6 in and 1450 mm / 57.1 in



product specification

Axial Sensitivity (dB SPL, 2.83 V @ 1 m)<sup>7,8</sup>

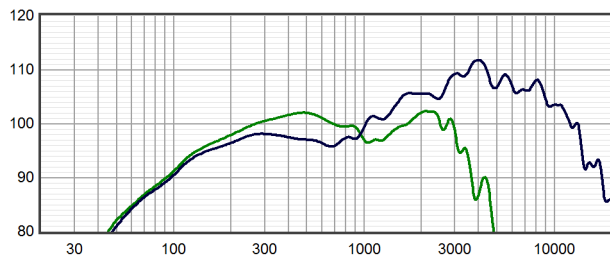

Horizontal Off Axis Response<sup>7,11</sup>

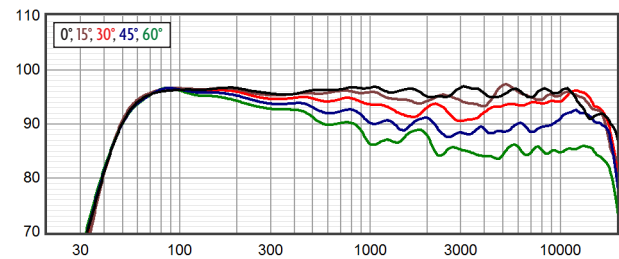

Axial Processed Response (dB)<sup>7,9</sup>

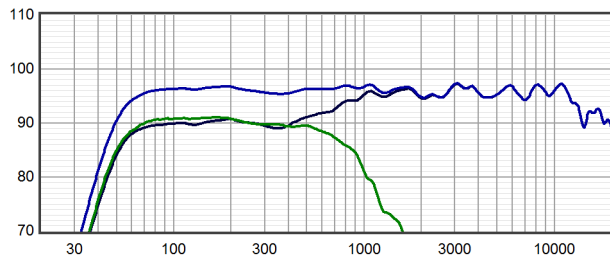

Vertical Off Axis Response<sup>7,11</sup>

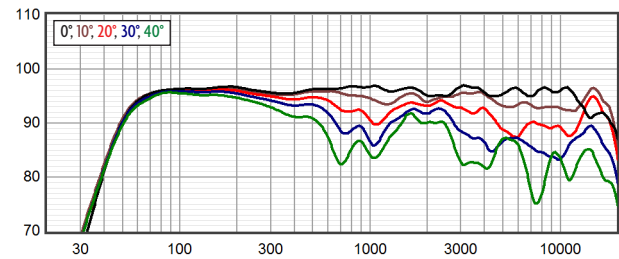

Axial Processed Phase Response (degrees)<sup>7,10</sup>

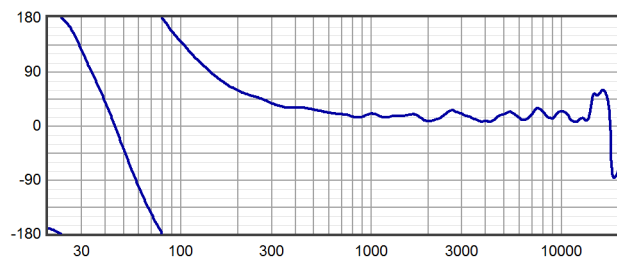

Beamwidth<sup>7,12</sup>

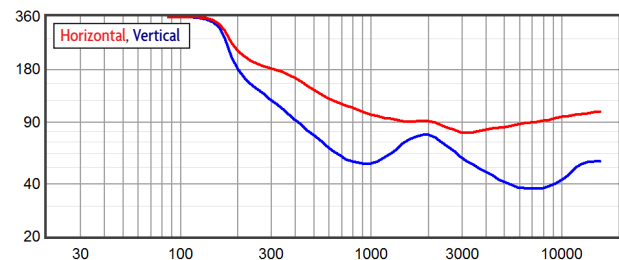

Impedance (ohms)

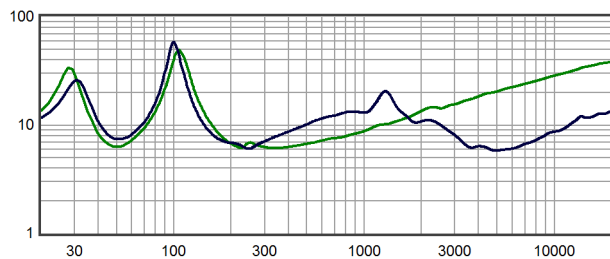

Directivity Index (dB)<sup>13</sup>

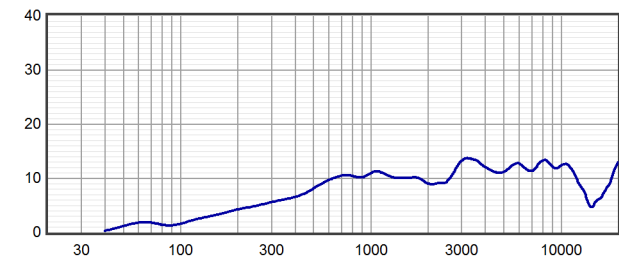



product specification

Horizontal Polar Response (30 dB Scale, 6 dB per Major Division)

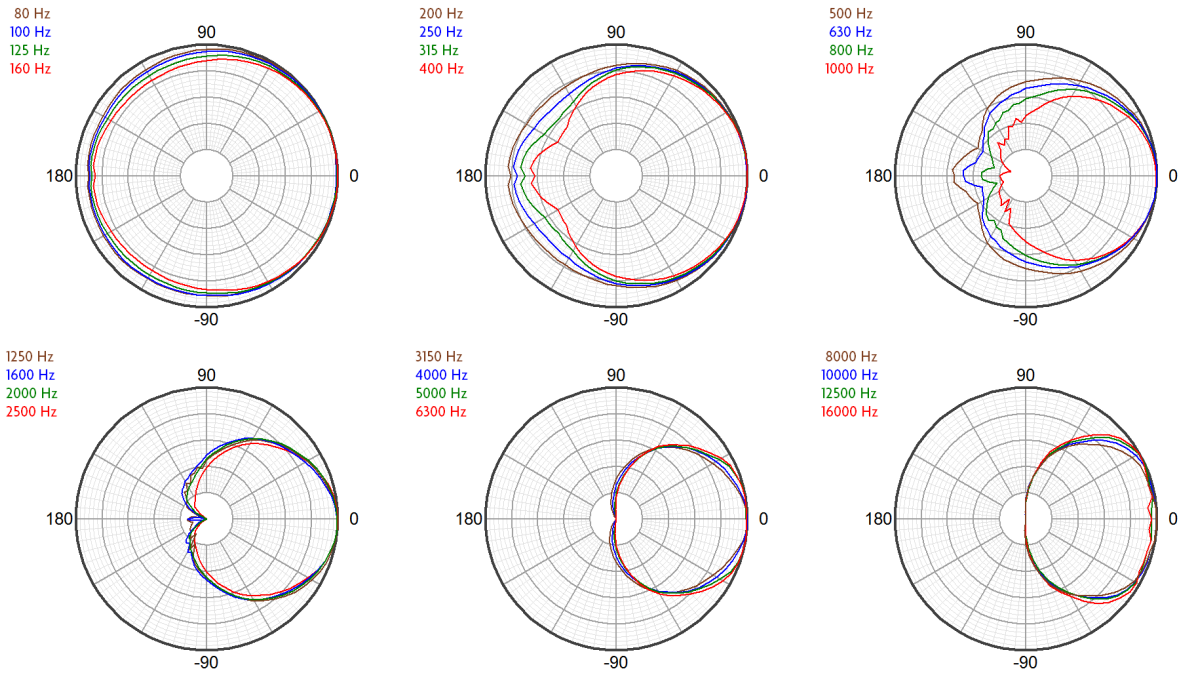

Vertical Polar Response (30 dB Scale, 6 dB per Major Division)

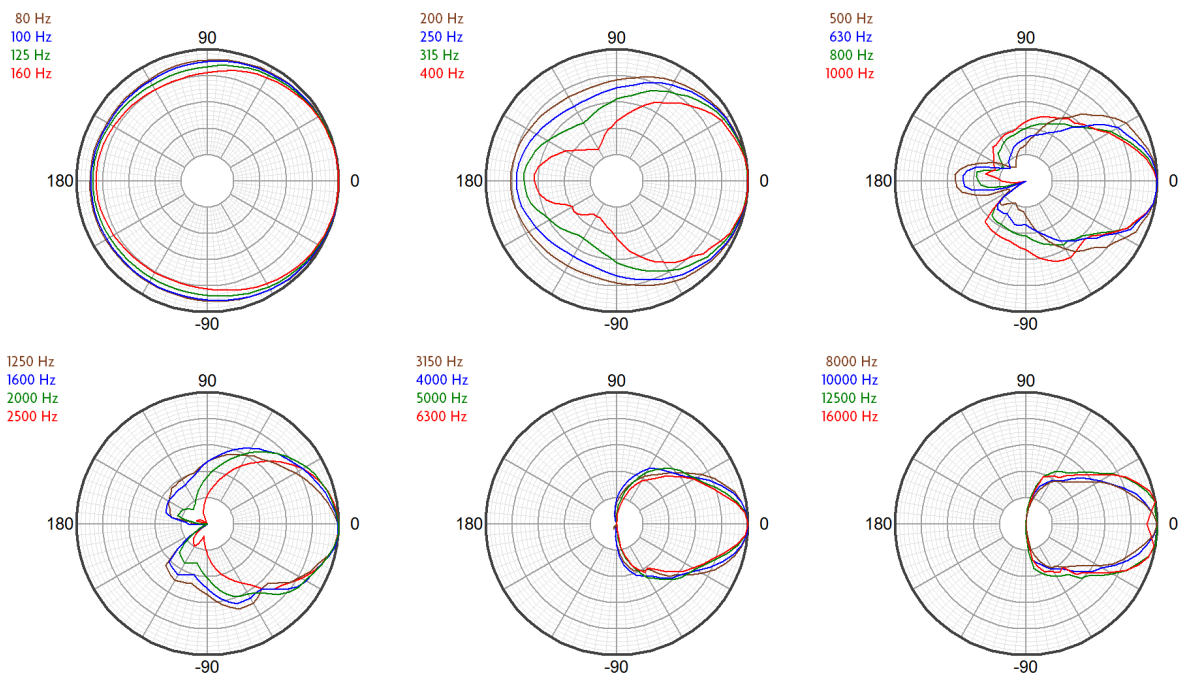



## product specification

### Technologies

The proprietary horn employed in the FA22 represents a modern digital-signal-processing-aware update to the traditional horn-loaded coaxial loudspeaker concept. The well-known benefits of the coaxial approach have been realized without the familiar shortcomings of historical designs. Fulcrum Acoustic's **Temporal Equalization™ (TQ™)** digital signal processing techniques eliminate midrange colorations and high frequency harshness while producing a smooth, seamless coverage pattern through the crossover range. In fact, the coaxial transducers were designed from the ground up to take advantage of the unique capabilities of TQ™.

The coaxial transducer in the FA22 includes a 3 inch diaphragm compression driver. The large diaphragm area permits the compression driver to operate at frequencies too low for smaller

compression drivers to handle. This allows the high frequency horn to smooth the polar response of the low frequency section in the frequency range where the horn would otherwise cause shadowing. It also allows the compression driver to produce extreme sound pressure levels with an effortless sonic character. The coaxial woofer's large radiating surface works in conjunction with the HF horn to improve directional control at the bottom of the horn's operating range, increasing directional control beyond what can be accomplished by the horn alone.

The two low frequency devices both operate down to the lowest frequencies, resulting in mutual coupling that provides unusually high efficiency and impact in the critical 40 Hz to 500 Hz range.

### Connection Diagram

3-way, Bi-Amp

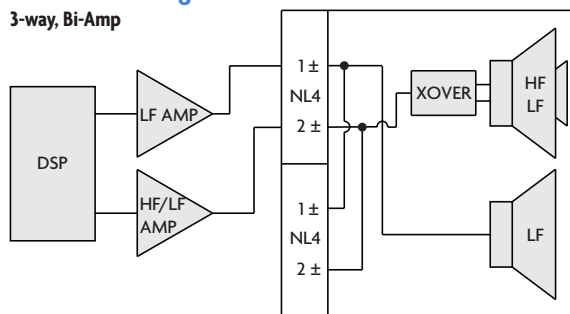

### Mechanical Specification Drawings

2D and 3D DXF dimensional drawings are available for download at [www.fulcrum-acoustic.com/support](http://www.fulcrum-acoustic.com/support).

### Notes

- <sup>1</sup> **Performance Specifications** All acoustic specifications rounded to nearest whole number. External DSP with Fulcrum Acoustic-provided settings is required to achieve the specified performance.
- <sup>2</sup> **Operating Range** The frequency range within which the processed response is within 10 dB of the average.
- <sup>3</sup> **Power Handling** Based on the AES power handling of the transducers.
- <sup>4</sup> **Nominal Sensitivity** The 1-meter-referenced SPL produced by a 1 watt band limited pink noise signal, with no processing applied.
- <sup>5</sup> **Equalized Sensitivity** The 1-meter-referenced SPL produced when an EIA-426-B signal is applied to an equalized loudspeaker system, at a level which produces a total power of 1 watt, in sum, to the loudspeaker subsections.
- <sup>6</sup> **Equalized Maximum SPL** The 1-meter-referenced SPL produced when an EIA-426-B signal is applied to an equalized loudspeaker system, at a level which drives at least one subsection to its rated power.
- <sup>7</sup> **Resolution** All response graphs are subjected to 1/6 octave cepstral smoothing with a gaussian weighting function.
- <sup>8</sup> **Axial Sensitivity** The SPL plotted against frequency for a 1 watt swept sine wave, referenced to 1 m with no signal processing.
- <sup>9</sup> **Axial Processed Response** The axial magnitude response with recommended signal processing applied.
- <sup>10</sup> **Axial Processed Phase Response** The axial phase response with recommended signal processing applied, and latency removed.
- <sup>11</sup> **Horizontal / Vertical Off Axis Responses** The magnitude response at various angles off axis, with recommended signal processing applied.
- <sup>12</sup> **Beamwidth** The angle between the -6 dB points in a loudspeaker's polar response.
- <sup>13</sup> **Directivity Index (Di)** The ratio of the on-axis sound pressure squared to the spherical average of the sound pressure squared at a particular frequency expressed in dB. To convert the directivity index to directivity factor (Q) use the formula  $10^{Di/10}$ .