



AHC266

High Efficiency Full-Range Coaxial Horn

tq^{install}
SERIES™



Overview

The AHC266 is a bi-amplified 3-way, high sensitivity, arrayable coaxial horn loudspeaker that provides a precise 60° x 60° pattern with control to below 400 Hz, low frequency extension to 75 Hz, and extremely high output with modest amplifier power. Its unique **Compression Head™** horn architecture provides exceptional low frequency loading to its twin dual-coil 10 inch low frequency compression drivers, while a pair of **Oculus™** phase plugs extends the 10s' high frequency response to smoothly mesh with a coaxial ring-radiator high frequency compression driver. The AH66's unique 60° compact trapezoidal shape allows it to be mounted very close to ceilings with minimal effect on sight lines.

Sound, innovative acoustical design combined with Fulcrum Acoustic's **TQ™** processing leads to exceptional clarity and precise transient response, even at very high sound pressure levels. The required digital signal processing can be provided by one of many supported platforms.

The AHC266 is particularly effective in acoustically challenging spaces where broadband pattern control is necessary, and in applications requiring high acoustic output and high fidelity. Its **Compression Head™** horn architecture provides easy access to the drivers, so the AHC266 can be conveniently serviced while flown. Its clean aesthetic and relatively compact size complements many architectural styles, which facilitates acceptance by interior designers and architects. This makes it the perfect choice for houses of worship, sports facilities, theaters, night clubs, theme parks, and more.

Performance Specifications¹

Operating Mode

Bi-amplified w/ DSP

Operating Range²

75 Hz to 18 kHz

Nominal Beamwidth

60° x 60°

Transducers

LF: 2x 10.0" neodymium magnet cone driver, dual 3.5" voice coils
HF: 4.0"/2.5" voice coil coaxial ring-radiator compression driver

Power Handling @ Nominal Impedance³

LF: 113 V (1600 W @ 8 Ω)

HF: 49 V (300 W @ 8 Ω)

Nominal Sensitivity @ Input Voltage⁴ (whole space)

LF: 106 dB @ 2.83 V

HF: 109 dB @ 2.83 V

Nominal Maximum SPL (peak / continuous)

LF: 144 dB / 138 dB

HF: 140 dB / 134 dB

Equalized Sensitivity @ Input Voltage⁵

105 dB @ 2.83 V

Equalized Maximum SPL (peak / continuous)⁶

144 dB / 138 dB

Recommended Power Amplifiers

LF: 1600 W to 3200 W @ 8 Ω

HF: 300 W to 600 W @ 8 Ω

Physical Specifications

Connections

(2) Neutrik NL4 Speakon

Pin 1+/-: LF

Pin 2+/-: HF

Mounting / Suspension Points

(16) M10 x 1.5 eye bolt angle points, (2) M12 x 1.75 yoke points

Dimensions / Weight

See page 5

Finish

Black painted enclosure w/ matte black grille, or

White painted enclosure w/ matte white grille

Options

YK-AHC2x6 Yoke Bracket, Terminal strip input, Custom color finish, Weather-resistant (WR) enclosure & hardware



Axial Sensitivity (dB SPL, 2.83 V @ 1 m)^{7,8}

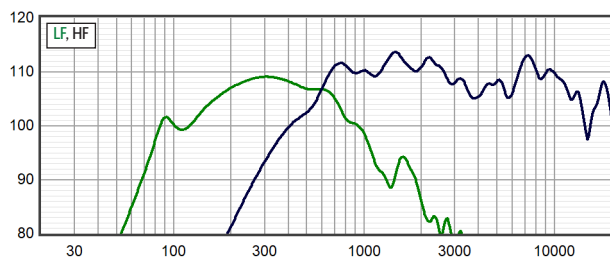

Horizontal Off Axis Response^{7,11}

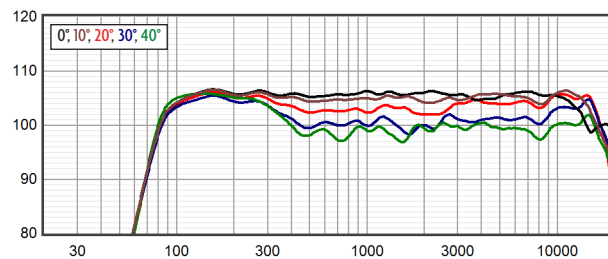

Axial Processed Response (dB)^{7,9}

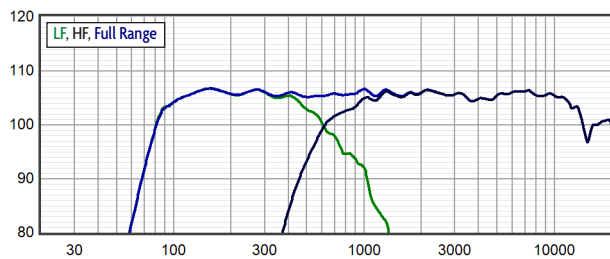

Vertical Off Axis Response^{7,11}

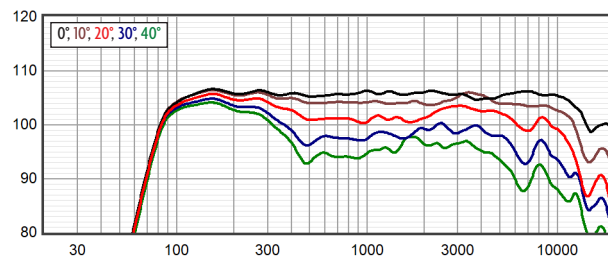

Axial Processed Phase Response (degrees)^{7,10}

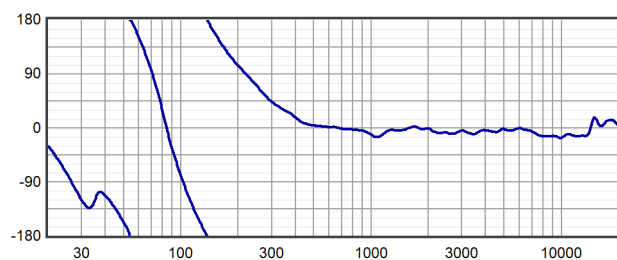

Beamwidth^{7,12}

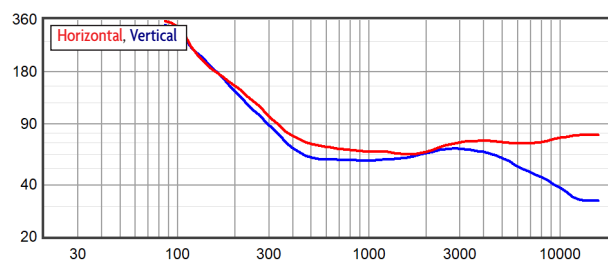

Impedance (ohms)

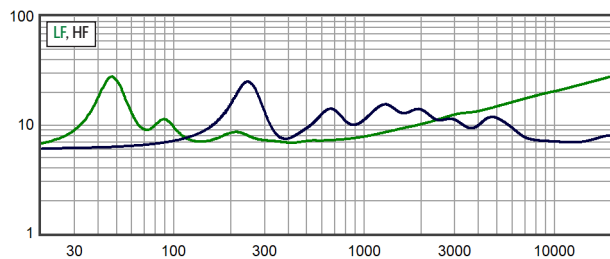

Directivity Index (dB)¹³

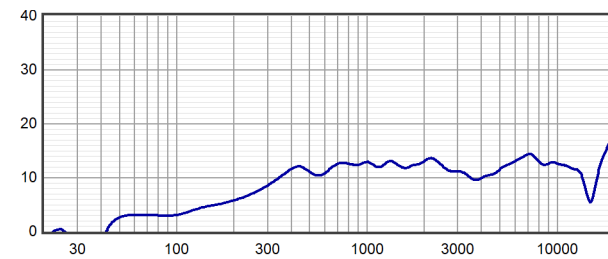



Horizontal Polar Response (30 dB Scale, 6 dB per Major Division)

80 Hz
100 Hz
125 Hz
160 Hz

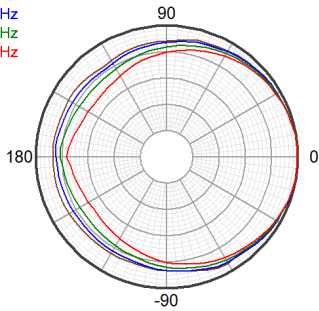

200 Hz
250 Hz
315 Hz
400 Hz

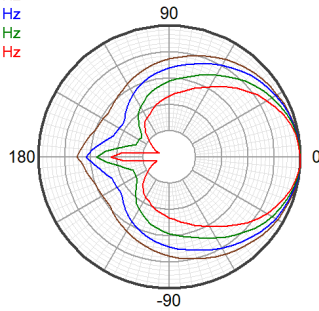

500 Hz
630 Hz
800 Hz
1000 Hz

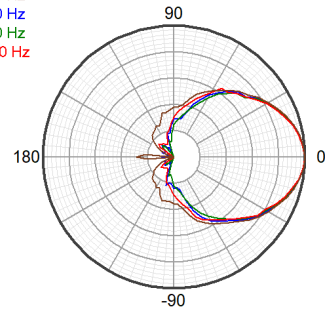

1250 Hz
1600 Hz
2000 Hz
2500 Hz

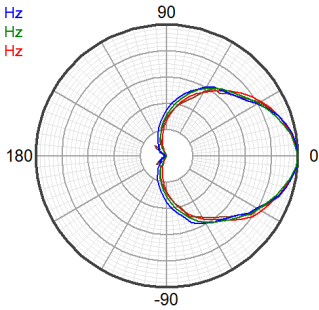

3150 Hz
4000 Hz
5000 Hz
6300 Hz

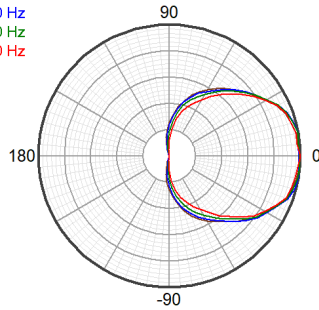

8000 Hz
10000 Hz
12500 Hz
16000 Hz

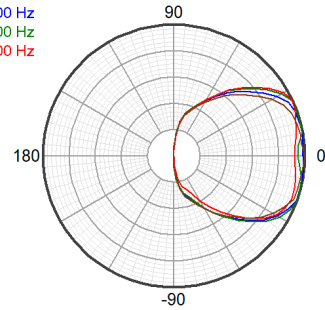

Vertical Polar Response (30 dB Scale, 6 dB per Major Division)

80 Hz
100 Hz
125 Hz
160 Hz

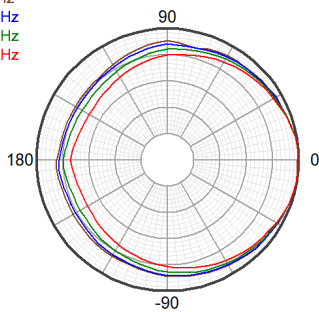

200 Hz
250 Hz
315 Hz
400 Hz

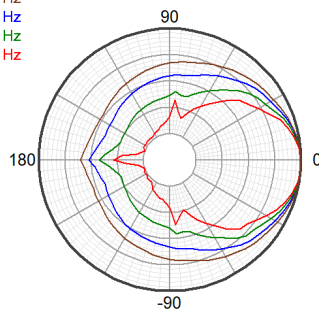

500 Hz
630 Hz
800 Hz
1000 Hz

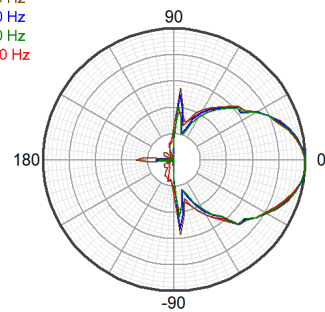

1250 Hz
1600 Hz
2000 Hz
2500 Hz

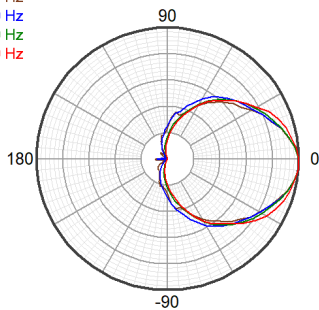

3150 Hz
4000 Hz
5000 Hz
6300 Hz

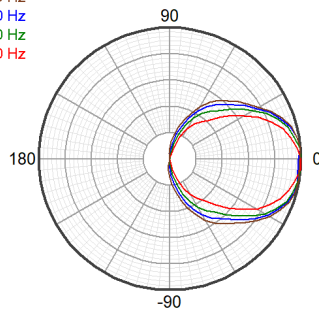

8000 Hz
10000 Hz
12500 Hz
16000 Hz

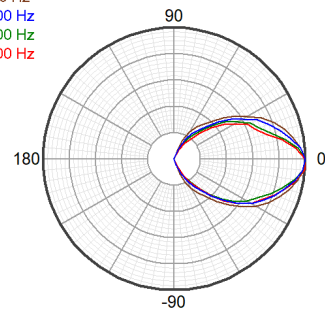



Technologies

The two **low frequency drivers** in the AHC266 each employ dual 3.5-inch voice coils in a high-energy neodymium magnet structure. This configuration provides exceptional thermal power handling, resulting in a combined 1600 watts of long-term power handling, as well as providing the prodigious motor strength necessary to drive the AHC266's low-frequency horn to its full potential.

The **compression driver** employs two coaxially positioned ring radiator diaphragms with 4.0 inch and 2.5 inch voice coils respectively. A patented acoustical filter combines the output of both diaphragms without the interference associated with other coaxial compression driver designs. This combination results in exceptionally high output capability, while TQ™ processing ensures the crisp, clean transient response expected of all Fulcrum Acoustic loudspeakers.

The AHC266's **Compression Head™** horn architecture couples a trapezoidal enclosure housing a pattern-control horn bell and rear-facing 10 inch drivers with a “compression head” – a removable acoustical labyrinth resembling the cylinder head of an engine. The compression head accurately positions two **Oculus™** phase plugs in front of the 10 inch cones, and delivers their output coherently to the entry of the horn bell, by way of an integral folded horn throat.

The **Oculus™ phase plug** employs two radially asymmetrical slots, precisely shaped and positioned to gather the pressure from the 10 inch driver's hemispherical compression chamber and deliver it in planar phase to a rectangular horn throat.

Connection Diagram

3-way, Bi-Amp

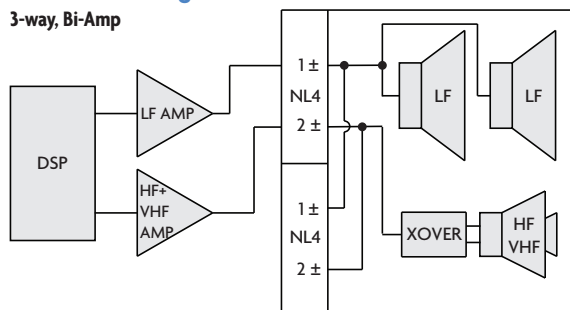

Mechanical Specification Drawings

2D and 3D DWG dimensional drawings are available for download at www.fulcrum-acoustic.com/support.

Notes

- ¹ **Performance Specifications** All acoustic specifications rounded to nearest whole number. External DSP with Fulcrum Acoustic-provided settings is required to achieve the specified performance.
- ² **Operating Range** The frequency range within which the processed response is within 10 dB of the average.
- ³ **Power Handling** Based on the AES power handling of the transducers.
- ⁴ **Nominal Sensitivity** The 1-meter-referenced SPL produced by a 1 watt band limited pink noise signal, with no processing applied.
- ⁵ **Equalized Sensitivity** The 1-meter-referenced SPL produced when an EIA-426-B signal is applied to an equalized loudspeaker system, at a level which produces a total power of 1 watt, in sum, to the loudspeaker subsections.
- ⁶ **Equalized Maximum SPL** The 1-meter-referenced SPL produced when an EIA-426-B signal is applied to an equalized loudspeaker system, at a level which drives at least one subsection to its rated power.
- ⁷ **Resolution** All response graphs are subjected to 1/6 octave cepstral smoothing with a gaussian weighting function.
- ⁸ **Axial Sensitivity** The SPL plotted against frequency for a 1 watt swept sine wave, referenced to 1 m with no signal processing.
- ⁹ **Axial Processed Response** The axial magnitude response with recommended signal processing applied.
- ¹⁰ **Axial Processed Phase Response** The axial phase response with recommended signal processing applied, and latency removed.
- ¹¹ **Horizontal / Vertical Off Axis Responses** The magnitude response at various angles off axis, with recommended signal processing applied.
- ¹² **Beamwidth** The angle between the -6 dB points in a loudspeaker's polar response.
- ¹³ **Directivity Index (Di)** The ratio of the on-axis sound pressure squared to the spherical average of the sound pressure squared at a particular frequency expressed in dB. To convert the directivity index to directivity factor (Q) use the formula $10^{Di/10}$.



product specification

Notes:

1. Net Weight = Approx. 112 lb / 50.8 kg
2. Ship Weight = Approx. 126 lb / 57.2 kg
3. Symbol = M10x1.5 eye bolt angle point
4. Symbol = M12x1.75 nut plate
5. Symbol = CoG
6. Symbol = Compression Head attachment point; do not use for suspension

REV	DESCRIPTION	APPR / DATE
1	NEW ISSUE	RAF 4/14/22

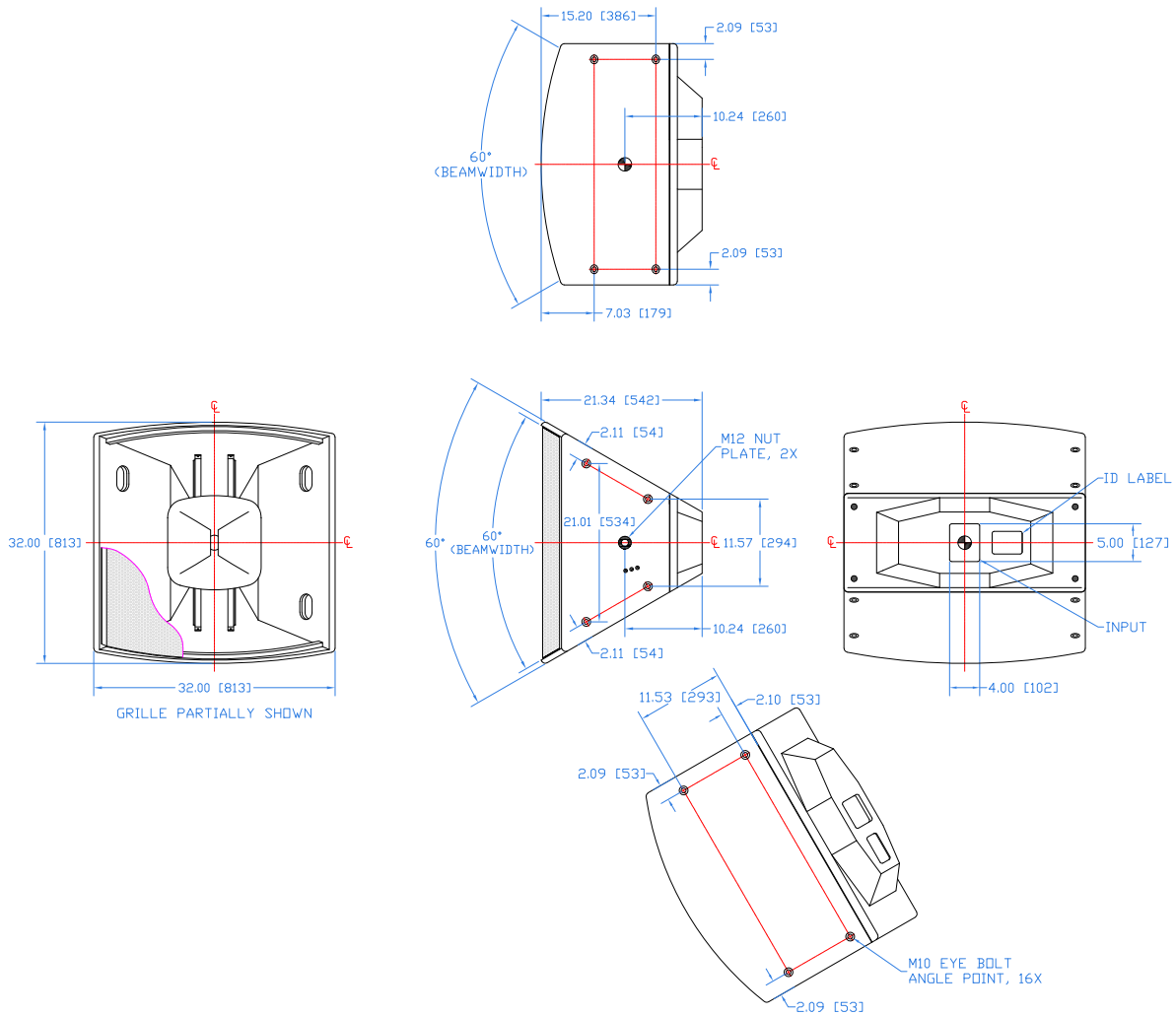

<p>THIRD ANGLE PROJECTION</p>	<p>UNLESS OTHERWISE SPECIFIED: ALL DIMENSIONS ARE IN INCHES</p> <p>TOLERANCE IN INCHES .XX1 .XX±.015 .XXX±.005 FRACTIONS ±1/32 ANGLES ±1/2°</p> <p>(XX.X) = REF DIMS NO TOLERANCE IMPLIED</p> <p>TSC = THEORETICAL SHARP CORNER</p> <p>DIMENSIONS ACROSS CENTERLINES TO BE SYMMETRICAL</p>	<p>STATUS RELEASED</p>		<p>FULCRUM ACOUSTIC, LLC 670 LINWOOD AVE., LINWOOD, MA 01525 USA</p>
		<p>APPROVALS</p> <p>DRAWN: RAF</p> <p>CHECKED: DEW</p> <p>DES ENG:</p> <p>MFG ENG:</p>	<p>DATE</p> <p>4/14/22</p> <p>4/14/22</p>	
<p>THIS DRAWING IS THE PROPERTY OF FULCRUM ACOUSTIC, AND SHALL NOT BE COPIED, REPRODUCED, OR USED AS THE BASIS FOR MANUFACTURE OR SALE OF APPARATUS WITHOUT WRITTEN AUTHORIZATION. DO NOT SCALE DRAWING.</p>		<p>DWG. NO. 820-100-145</p>	<p>SHEET 1 OF 1</p>	<p>SCALE: 1:20</p>
				<p>REV 1</p>

Drawing is reduced. Do not scale.



product specification, weather-resistant (WR) version

Notes:

1. Net Weight = Approx. 99.0 lb / 44.9 kg
2. Ship Weight = Approx. 120.0 lb / 54.4 kg
3. Symbol = M10x1.5 eye bolt angle point
4. Symbol = M12x1.75 nut plate
5. Symbol = CoG
6. Symbol = Compression Head attachment point; do not use for suspension.
7. Enclosure construction:
Fiberglass Reinforced Polyurethane

REVISIONS		
REV	DESCRIPTION	APPR / DATE
1	NEW ISSUE	RAF 4/14/22

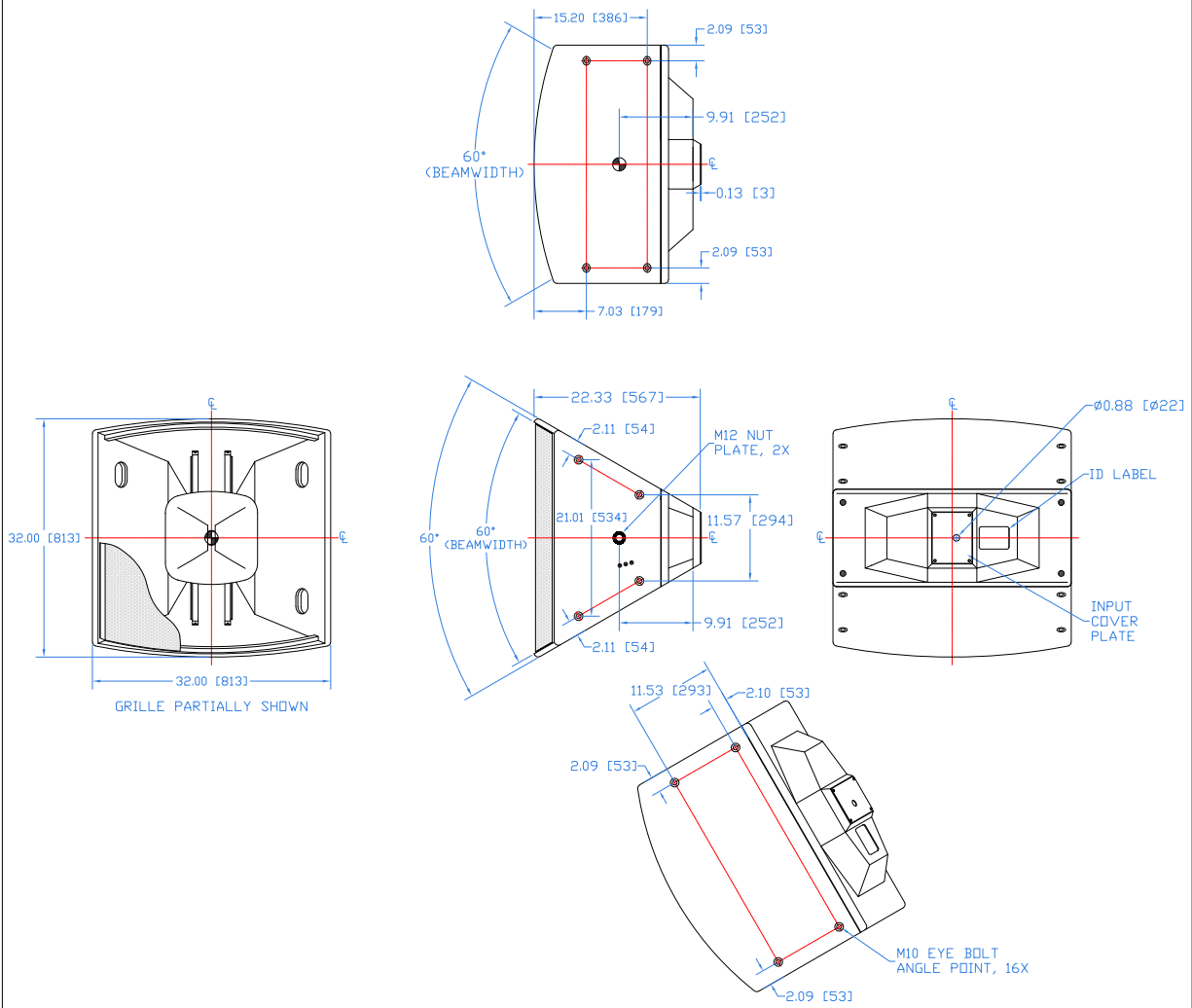

<p>THIRD ANGLE PROJECTION</p>	<p>UNLESS OTHERWISE SPECIFIED: ALL DIMENSIONS ARE IN INCHES</p> <p>TOLERANCE IN INCHES .XX1 .XX±.015 .XXX±.005 FRACTIONS ±1/32 ANGLES ±1/2°</p> <p>(.XXX) = REF DIMS NO TOLERANCE IMPLIED</p> <p>TSC = THEORETICAL SHARP CORNER</p> <p>DIMENSIONS ACROSS CENTERLINES TO BE SYMMETRICAL</p>	<p>STATUS RELEASED</p>		<p>FULCRUM ACOUSTIC, LLC 670 LINWOOD AVE., LINWOOD, MA 01525 USA</p>
		<p>APPROVALS</p> <p>DRAWN: RAF</p> <p>CHECKED: DEW</p> <p>DES ENG:</p> <p>MFG ENG:</p>	<p>DATE</p> <p>4/14/22</p> <p>4/14/22</p>	
<p>THIS DRAWING IS THE PROPERTY OF FULCRUM ACOUSTIC, AND SHALL NOT BE COPIED, REPRODUCED, OR USED AS THE BASIS FOR MANUFACTURE OR SALE OF APPARATUS WITHOUT WRITTEN AUTHORIZATION. DO NOT SCALE DRAWING.</p>		<p>DWG. NO. 820-100-146</p>	<p>SHEET 1 OF 1</p>	<p>SCALE: 1:20</p> <p>REV 1</p>

Drawing is reduced. Do not scale.

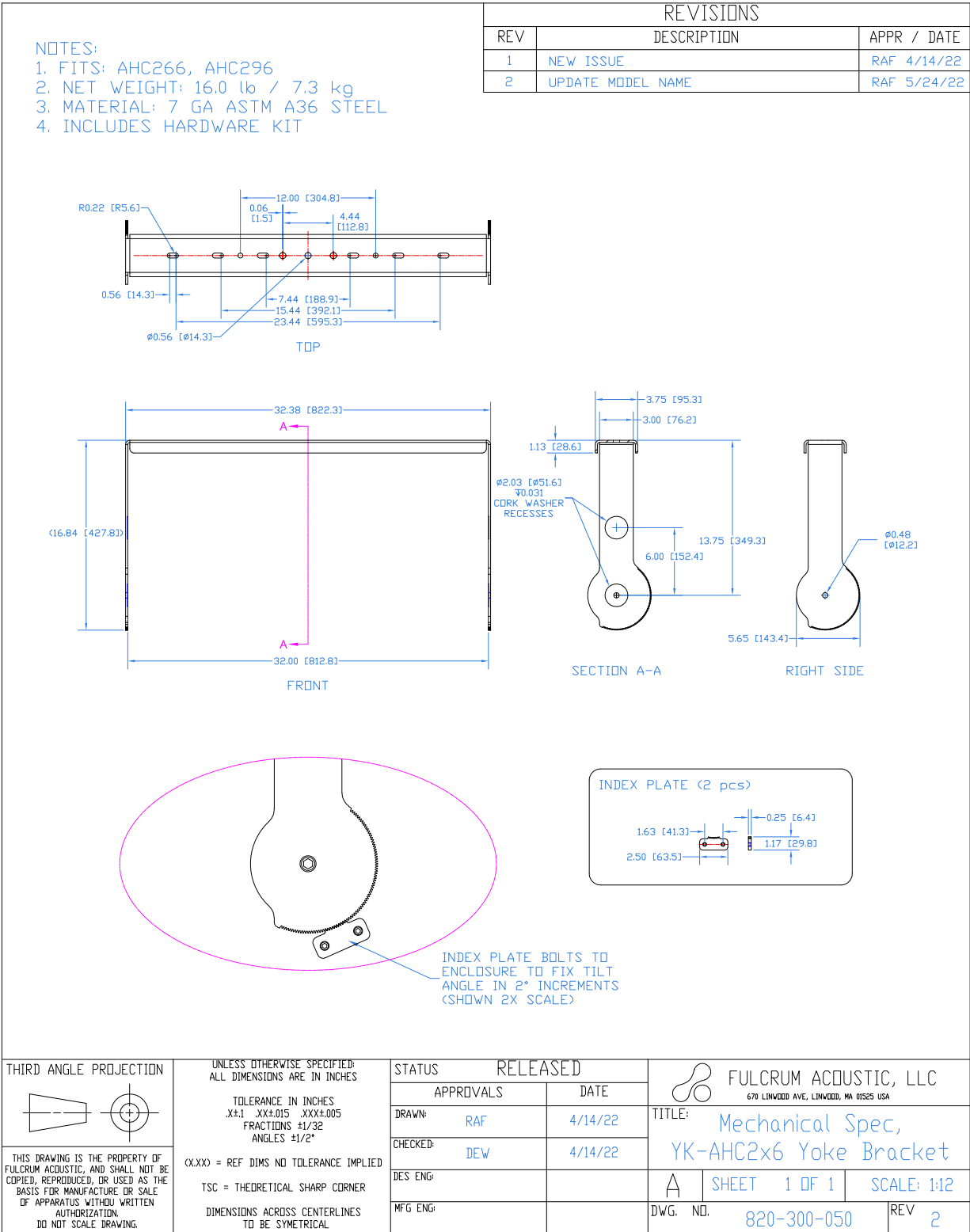

Drawing is reduced. Do not scale.